

Package: 3mmx3mm QFN



### Product Description

The FMS2014-001 is a low loss, high power, linear single-pole double-throw Gallium Arsenide antenna switch designed for use in mobile handset applications. The die is fabricated using the RFMD FLO5 0.5µm switch process technology, which offers excellent performance optimised for switch applications. The FMS2014-001 is designed for use in dual-, tri-, and quad-band GSM handset antenna switch modules and RF front end modules. It can also find use in other applications where high power and linear RF switching is necessary.

#### Optimum Technology Matching® Applied

- GaAs HBT
- GaAs MESFET
- InGaP HBT
- SiGe BiCMOS
- Si BiCMOS
- SiGe HBT
- GaAs pHEMT
- Si CMOS
- Si BJT
- GaN HEMT
- InP HBT
- RF MEMS
- LDMOS

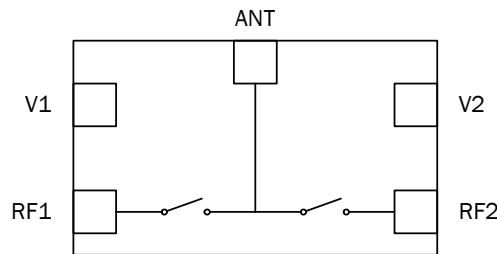

### Features

- Excellent Low Control Voltage Performance
- Excellent Harmonic Performance Under GSM/DCS/PCS/EDGE Power Levels
- Very High Tx-Rx Isolation: >28dB typ. at 1.8GHz
- Very Low Insertion Loss: 0.5dB at 1.8GHz
- Very Low Control Current

### Applications

- Mobile Handset Applications
- Dual-, Tri-, and Quad-band GSM Handset Antenna Switch Modules
- RF Front End Modules

Parameter	Specification			Unit	Condition
	Min.	Typ.	Max.		
<b>Electrical Specifications</b>					$T_{AMBIENT} = 25^{\circ}C$ , $V_{CTRL} = 0V/2.5V$ , $Z_{IN} = Z_{OUT} = 50\Omega$ External DC-blocking capacitors are required on all RF ports (typ. 700pF)
Insertion Loss		0.45	0.5	dB	0.5 GHz to 1.0GHz
		0.5	0.55	dB	1.0GHz to 2.0GHz
Return Loss	16	20		dB	0.5GHz to 2.5GHz
Isolation	-30	-32		dB	0.5GHz to 1.0GHz
	-26	-30		dB	1.0GHz to 2.0GHz
2nd Harmonic Level	-60	-70		dBc	1GHz, $P_{IN} = +35$ dBm, 100% duty cycle
	-65	-75		dBc	2GHz, $P_{IN} = +33$ dBm, 100% duty cycle
3rd Harmonic Level	-60	-70		dBc	1GHz, $P_{IN} = +35$ dBm, 100% duty cycle
	-65	-75		dBc	2GHz, $P_{IN} = +33$ dBm, 100% duty cycle
Switching Speed: $T_{RISE}$ , $T_{FALL}$		<0.3	1.0	µs	10% to 90% RF and 90% to 10% RF
Switching Speed: $T_{ON}$ , $T_{OFF}$		<0.3	1.0	µs	50% control to 90% RF and 50% control to 10% RF
Control Current		5	10	µA	+35dBm RF input at 1GHz
<b>General Test Conditions</b>					
Bias Voltages (Low)	0		0.2	V	
Bias Voltages (High)	2.5		5	V	
Port Impedances		50		Ω	
Off Arm Termination		50		Ω	

## Absolute Maximum Ratings<sup>1</sup>

Parameter	Rating	Unit
Maximum Input Power ( $P_{IN}$ )	+38	dBm
Control Voltage ( $V_{CTRL}$ )	+5	V
Operating Temperature ( $T_{OPER}$ )	-40 to 100	°C
Storage Temperature ( $T_{STOR}$ )	-55 to 150	°C



**Caution!** ESD sensitive device.

Exceeding any one or a combination of the Absolute Maximum Rating conditions may cause permanent damage to the device. Extended application of Absolute Maximum Rating conditions to the device may reduce device reliability. Specified typical performance or functional operation of the device under Absolute Maximum Rating conditions is not implied.

RoHS status based on EU Directive 2002/95/EC (at time of this document revision).

The information in this publication is believed to be accurate and reliable. However, no responsibility is assumed by RF Micro Devices, Inc. ("RFMD") for its use, nor for any infringement of patents, or other rights of third parties, resulting from its use. No license is granted by implication or otherwise under any patent or patent rights of RFMD. RFMD reserves the right to change component circuitry, recommended application circuitry and specifications at any time without prior notice.

## Truth Table

Switch State	VC1	VC2	ANT - RF1	ANT - RF2
A	High	Low	Insertion loss	Isolation
B	Low	High	Isolation	Insertion Loss

## Typical Measured Performance on Evaluation Board (De-embedded)

Measurement Conditions:  $V_{CTRL}$  = 2.5V (high) and 0V (low),  $T_{AMBIENT}$  = 25°C unless otherwise stated.

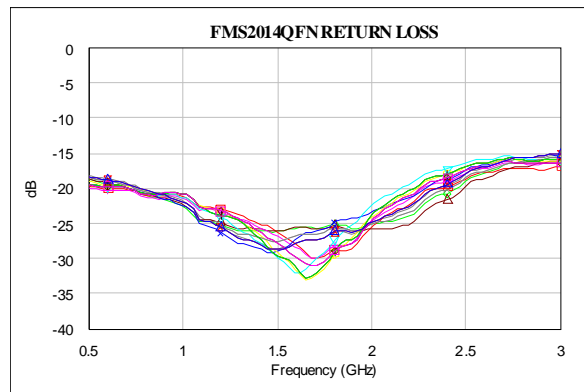
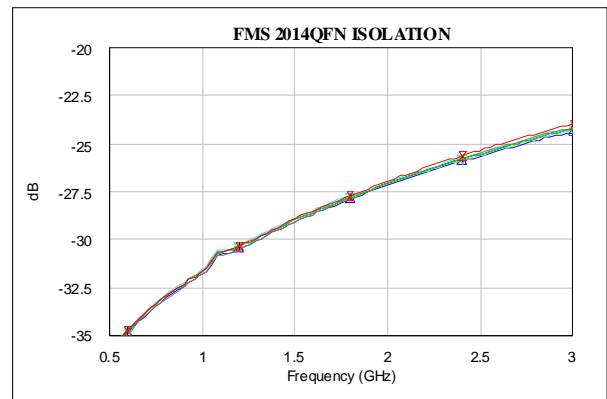
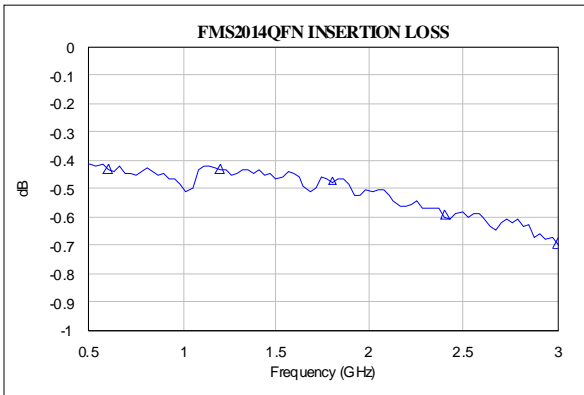

**Part Identification**

Marking

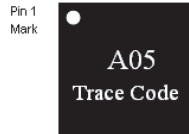

- 1st row Device code 'A05'
- 2nd row Trace Code to be assigned by SubCon

**Pad Layout**

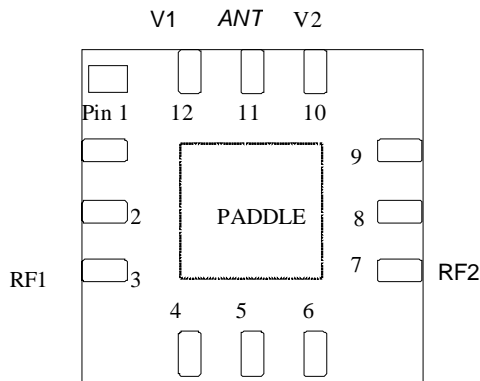

Pin	Description
1	NC
2	NC
3	RF1
4	NC
5	NC
6	NC
7	RF2
8	NC
9	NC
10	V2
11	ANT RF
12	V1
Paddle	Ground

**Package Drawing**

QFN 12-Lead 3mmx3mm

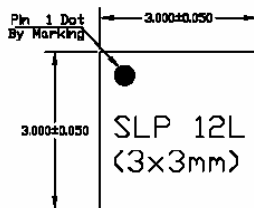

Top View

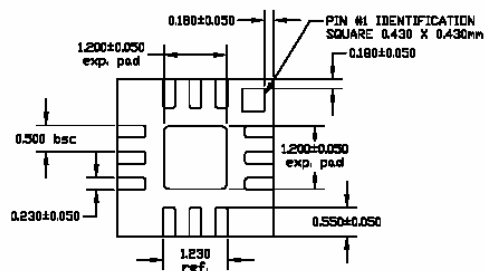

Btm View

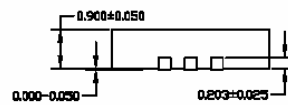

Side View

## Evaluation Board Layout

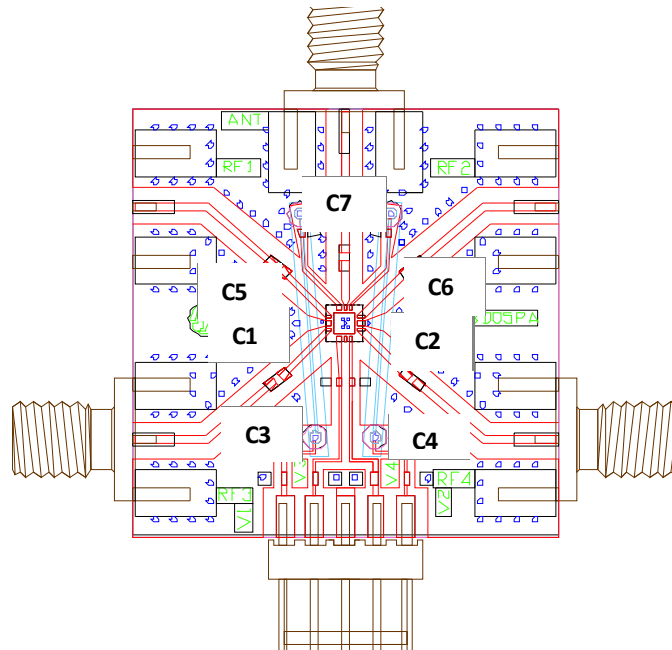

### Bill of Materials

Label	Component
C3, C4	Capacitor, 470 pF, 0603
C1, C2, C7	Capacitor, 100 pF, 0402
C5, C6	Capacitor, 47 pF, 0402
Board	Preferred evaluation board material is 0.25mm thick ROGERS RT4350. All RF tracks should be 50Ω characteristic impedance.

### Tape and Reel

Tape and reel information on this material is in accordance with EIA-481-1 except where exceptions are identified.

**Preferred Assembly Instructions**

This package is compatible with both lead free and leaded solder reflow processes as defined within IPC/J-STD-020C. The maximum package temperature should not exceed 260 °C.

**Handling Precautions**



To avoid damage to the devices, care should be exercised during handling. Proper Electrostatic Discharge (ESD) precautions should be observed at all stages of storage, handling, assembly, and testing.

**ESD Rating**

These devices should be treated as Class 1A (250V to 500V) as defined in JEDEC Standard No. 22-A114. Further information on ESD control measures can be found in MIL-STD-1686 and MIL-HDBK-263.

**MSL Rating**

The device has an MSL rating of Level 1. To determine this rating, preconditioning was performed to the device per the Pb-free solder profile defined within IPC/JEDEC J-STD-020C, moisture/reflow sensitivity classification for non-hermetic solid state.

**Application Notes and Design Data**

Application Notes and design data including S-parameters are available on request from [www.rfmd.com](http://www.rfmd.com).

**Reliability**

An MTTF of 4.2 million hours at a channel temperature of 150 °C is achieved for the process used to manufacture this device.

**Disclaimers**

This product is not designed for use in any space-based or life-sustaining/supporting equipment.

**Ordering Information**

Ordering Code	Description
FMS2014-001	7" Reel with 1000 pcs
FMS2014-001SR	7" reel with 100 pieces
FMS2014-001SQ	Sample bag with 25 pcs
FMS2014-001-EB	Packaged Die Mounted on Evaluation Board

